

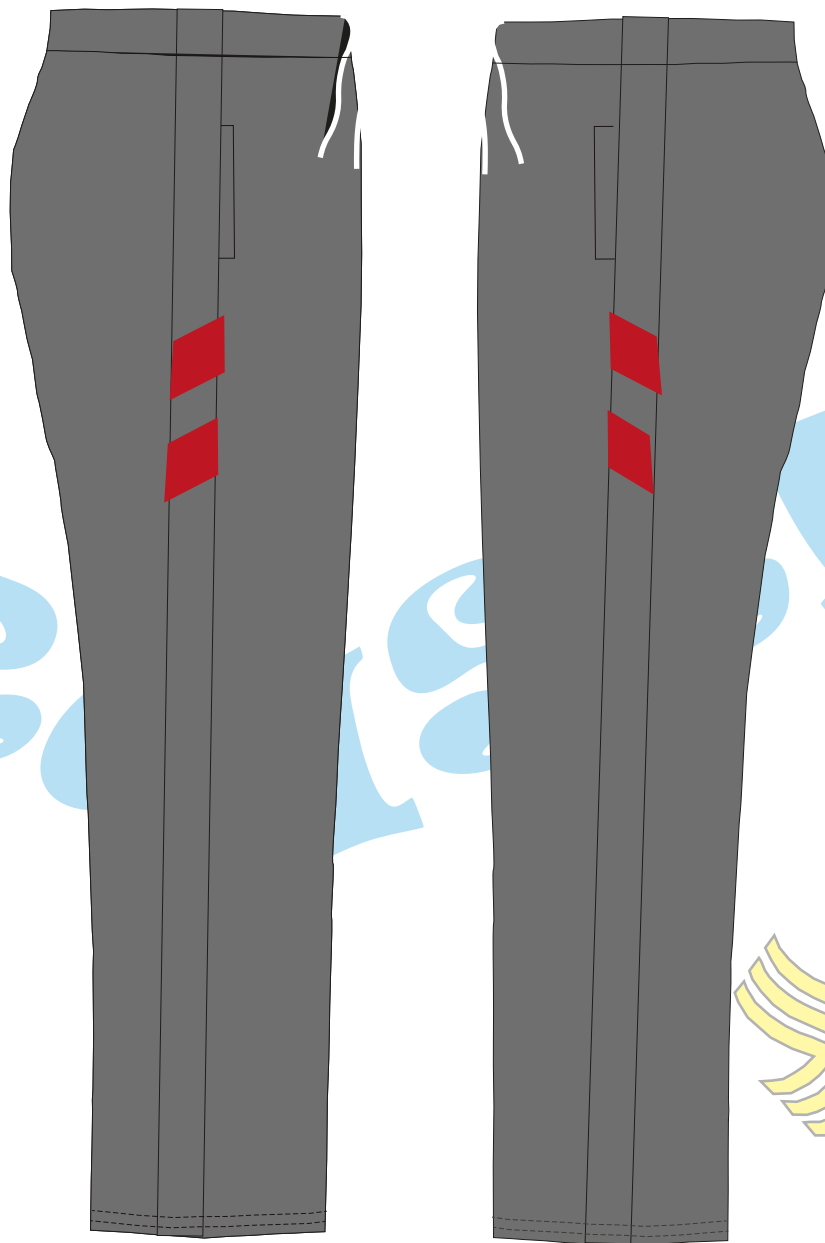

RUISELL

Cliente Monte Grande (A Coruña)
Colegio Monte Grande (A Coruña)
Modelo3429
Color 1003



Tallas 0 1 2 4 6 8 10 12 14 16 18 20 22 24 26 28

Guarderia 00 0 2 4 6 8

Composición 100% poliéster Acetato mate



Descripción Pantalón chandal 2 bolsilos, franja lateral con tiras bias C-10

Observaciones



RUISELL

Cliente Monte Grande (A Coruña)
Colegio Monte Grande (A Coruña)
Modelo3428
Color 1003



Tallas 0 1 2 4 6 8 10 12 14 16 18 20 22 24 26 28

Guarderia 00 0 2 4 6 8

Composición 100% poliéster Acetato mate



Descripción Chaqueta chandal piezas canesu, piezas en mangas, espalda y cuello C-03, bolsillos normales, cremallera C-03, goma puño

Observaciones Bordado pecho C-06



RUISELL

Cliente Monte Grande
Colegio Monte Grande
Modelo 6094
Color 0310

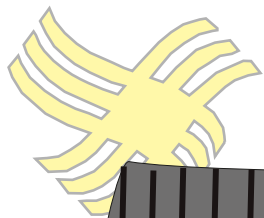

Tallas 0 2 4 6 8 10 12 14 16 18 20 22 24 26 28

Guarderia 00 0 2 4 6 8

Composición 100% poliéster acetato mate sin perchar 

Descripción Bermuda deporte 2 bolsillos, franja con tiras c-10.

Observaciones



RUISELL

Cliente Monte Grande
Colegio Monte Grande
Modelo 4147
Color 20



Tallas 0 2 4 6 8 10 12 14 16 18 20 22 24 26 28

Guarderia 00 0 2 4 6 8

Composición 50% poliéster 50% algodón



Descripción Camiseta mc c-rdo, tiras bias verticales C-1006, cuello punto

Observaciones Bordado pecho logo



RUISELL

Cliente Monte Grande
Colegio Monte Grande
Modelo 824
Color 10



Tallas 0 2 4 6 8 10 12 14 16 18 20 22 24 26 28

Guarderia 00 0 2 4 6 8

Composición 50% poliéster 50% algodón felpa perchada     

Descripción Sudadera c-rdo, bajos y puños canele

Observaciones Bordado pecho logo



RUISELL

Cliente Monte Grande
Colegio Monte Grande
Modelo 1241
Color 20



Tallas 0 2 4 6 8 10 12 14 16 18 20 22 24 26 28

Guarderia 00 0 2 4 6 8

Composición 50% poliéster 50% algodón



Descripción Polo mc, cuello y bocamangas con 2 listas C-10

Observaciones Bordado pecho logo



RUISELL

Cliente Monte Grande
Colegio Monte Grande
Modelo 1242
Color 20

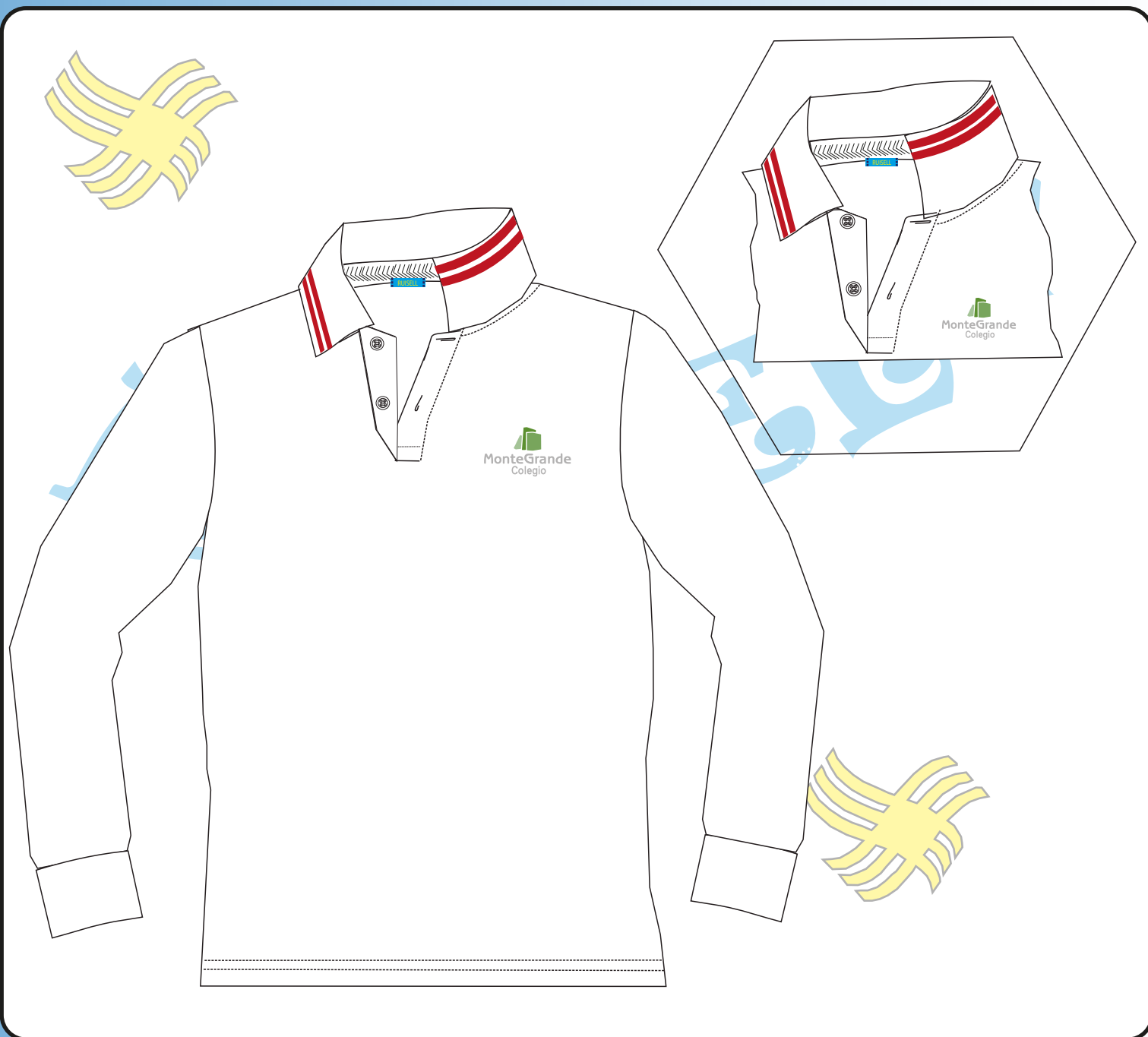

Tallas 0 2 4 6 8 10 12 14 16 18 20 22 24 26 28

Guarderia 00 0 2 4 6 8

Composición 50% poliéster 50% algodón



Descripción Polo ml, cuello 2 listas C-10, puños canale

Observaciones Bordado pecho logo



RUISELL

Cliente Monte Grande
Colegio Monte Grande
Modelo 5004
Color 1020

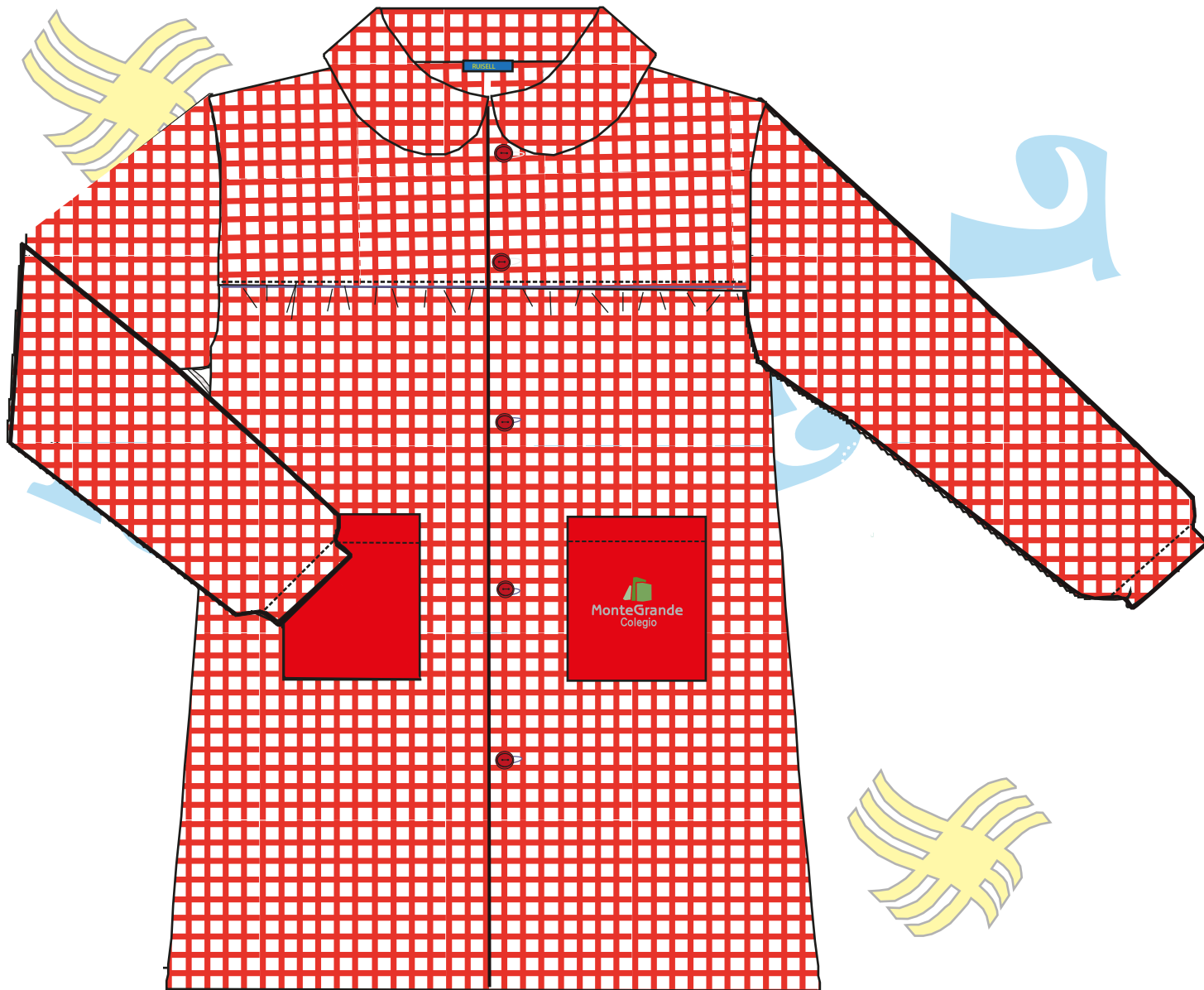

Tallas 0 2 4 6 8 10 12 14 16 18 20 22 24 26 28

Guarderia 00 0 2 4 6 8

Composición 70% poliéster 30% algodón



Descripción Babero c-bebe, 2 bolsillos, puño goma, botones C-10

Observaciones Bordado bolsillo logo



RUISELL

Cliente Monte Grande
Colegio Monte Grande
Modelo 7033
Color 03

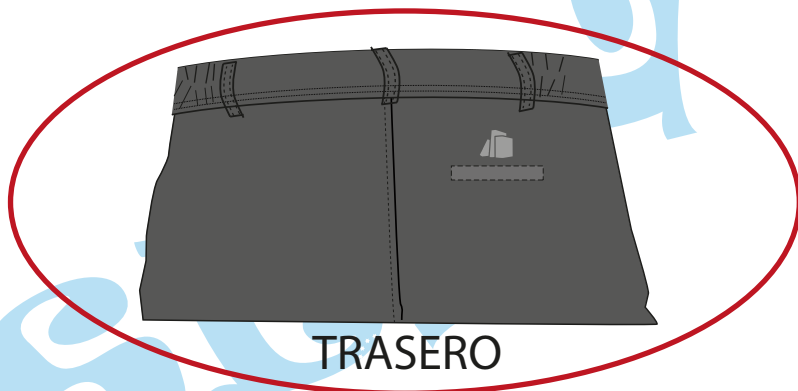
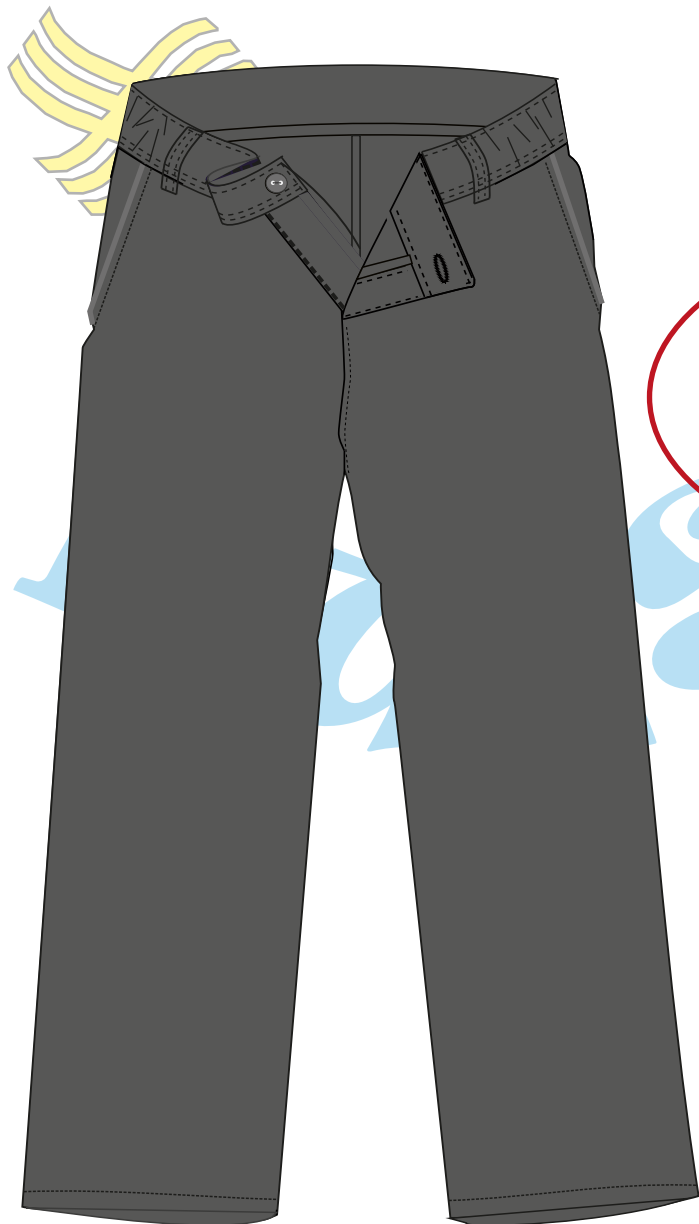

TRASERO



Tallas 0 2 4 6 8 10 12 14 16 18 20 22 24 26 28

Guarderia 00 0 2 4 6 8

Composición 67% poliéster 33% viscosa



Descripción Pantalón largo vestir, 2 bolsillos frances con bias en el canto y trasero bolsillo tapa con bias c-06

Observaciones Bordado trasero logo



RUISELL

Cliente Monte Grande
Colegio Monte Grande
Modelo 7034
Color 03

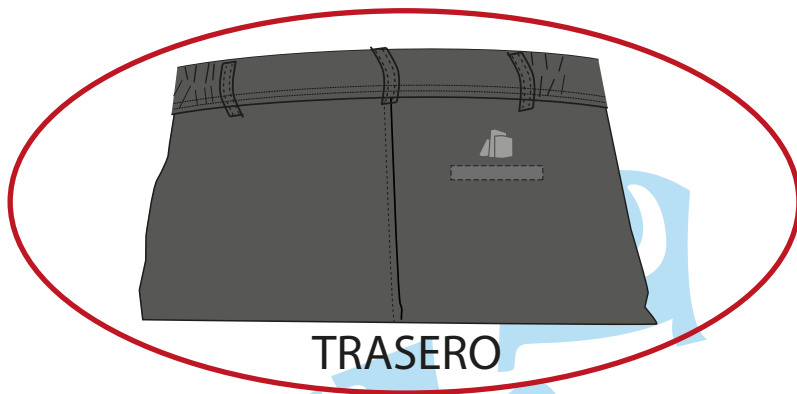

TRASERO

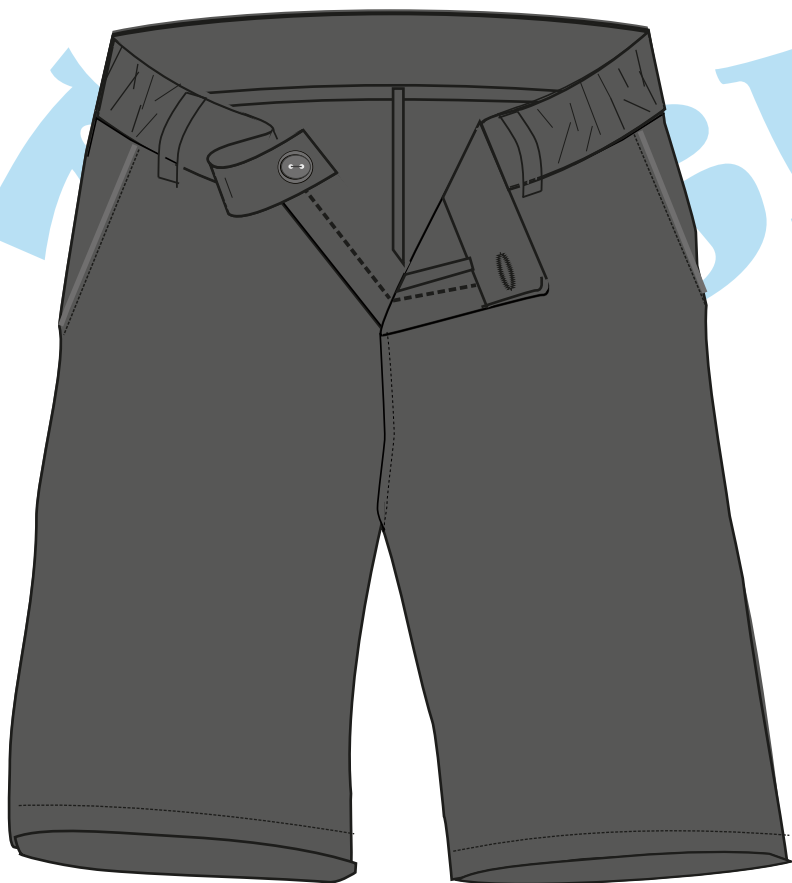

Tallas 0 2 4 6 8 10 12 14 16 18 20 22 24 26 28

Guarderia 00 0 2 4 6 8

Composición 67% poliéster 33% viscosa



Descripción Pantalón corto vestir, 2 bolsillos frances con bias en el canto y trasero bolsillo tapa con bias c-06

Observaciones Bordado trasero logo



RUISELL

Cliente Monte Grande
Colegio Monte Grande
Modelo 8067
Color 03

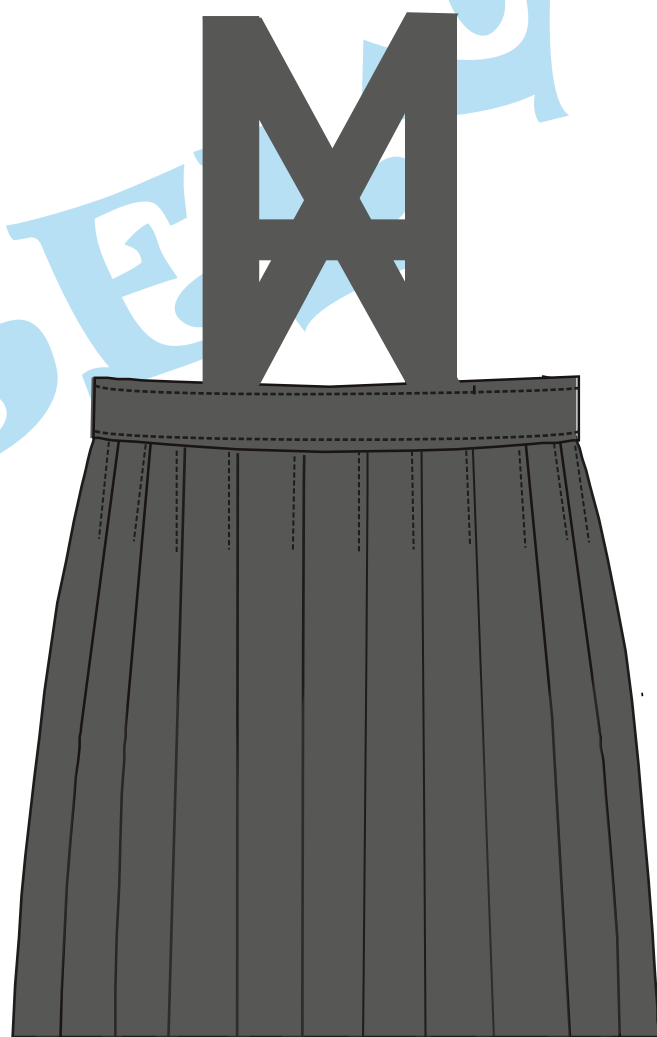
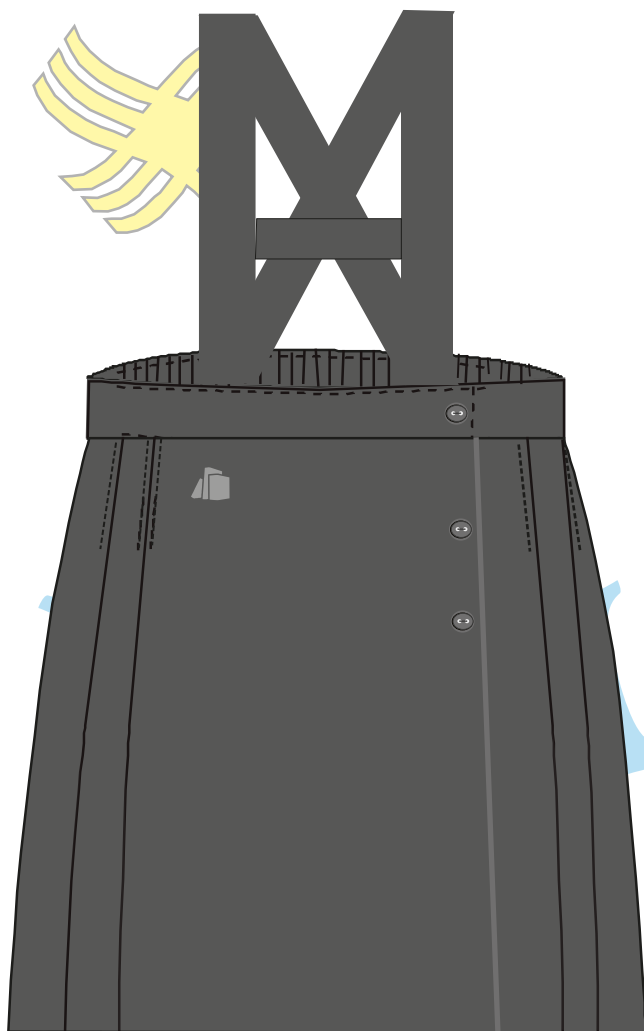

Tallas 0 2 4 6 8 10 12 14 16 18 20 22 24 26 28

Guarderia 00 0 2 4 6 8

Composición 67% poliéster 33% viscosa



Descripción Falda plisada pala 3 botones, con biesal canto c-06, tirantes T-1 a la 6

Observaciones Bordado logo

MEDIDAS DE CONTROL DE PRENDAS TERMINADA

MOD: BABERO

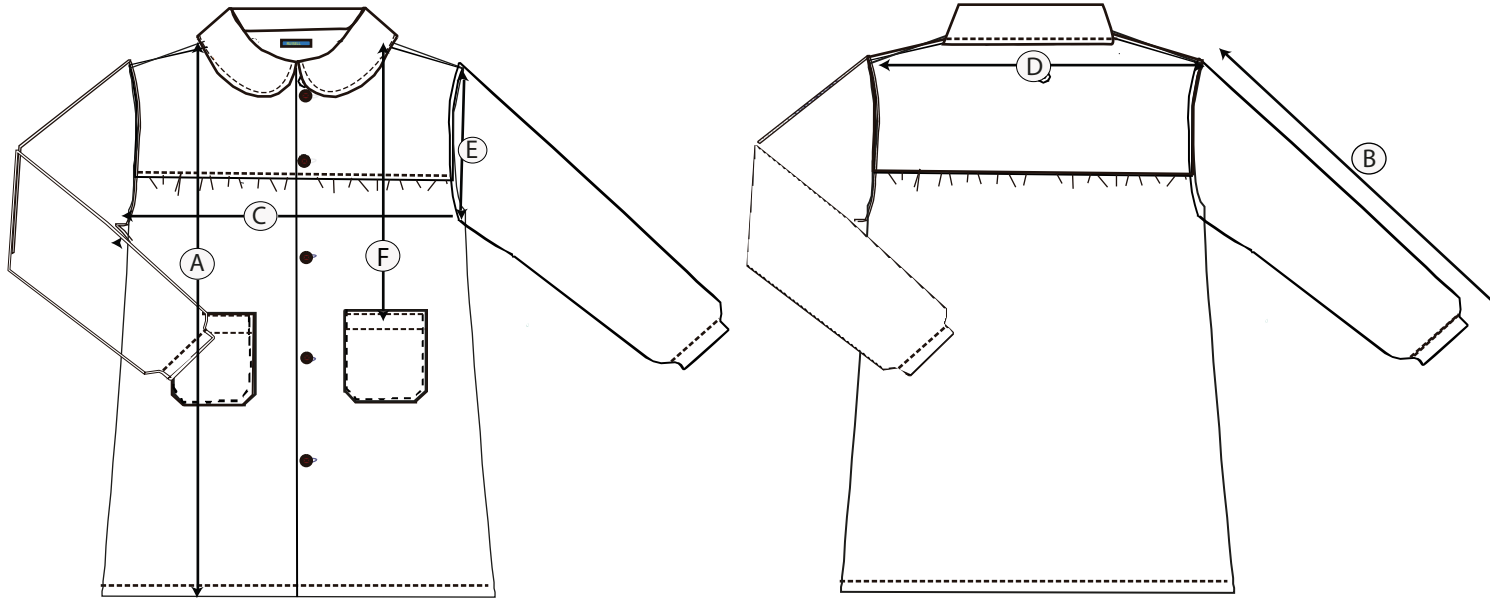

MEDIDA (mm)	REF.	T0	T1	T2	T4	T6	T8	T10	T12	T14	T16	T18	T20	T22	T24
Largo	A	440	480	560	640	700	770	820	870	940	970	1000	1010	1020	1030
Largo Manga	B	280	300	350	390	420	460	510	540	560	570	580	590	600	610
Contorno	C	330	350	370	390	430	450	470	500	570	610	630	650	670	690
Espalda	D	280	300	320	330	350	370	390	410	420	440	470	490	500	510
Sisa	E	170	170	180	190	210	230	240	250	260	270	280	290	300	310
Altura Bolsillo	F	300	300	310	330	350	360	380	400	430	460	480	500	520	540

OBSERVACIONES:

03/6/2019

MOD: Bermuda deportiva corta

MEDIDAS DE CONTROL DE PRENDAS TERMINADA

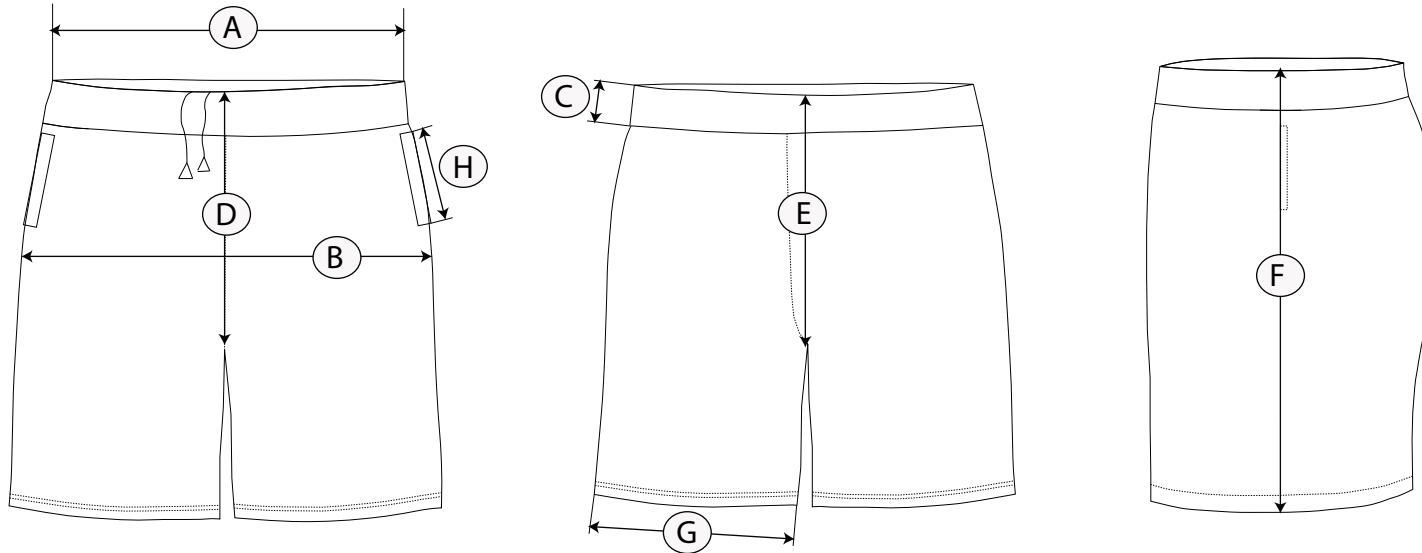

MEDIDAS(mm)	ref.	t0	t1	t2	t4	t6	t8	t10	t12	t14	t16	t18	t20	t22	t24
Cintura (funcida)	A	210	220	230	240	250	260	270	280	300	310	320	330	350	360
Cadera	B	310	330	350	380	400	430	460	480	510	530	550	570	590	610
Ancho cinturilla	C	35	35	35	35	35	35	35	35	35	35	35	35	35	35
Caja delantero	D	200	210	215	225	235	245	260	270	280	290	300	310	325	330
Caja trasero	E	240	250	260	270	280	295	310	320	345	350	360	380	390	405
Largo por costado	F	250	270	290	310	340	370	400	420	440	460	480	500	520	540
Bajo 1/2	G	175	180	185	200	210	210	220	230	240	255	280	300	310	320

OBSERVACIONES:

MOD: Camiseta manga corta

Camiseta manga larga

MEDIDAS DE CONTROL DE PRENDAS TERMINADA

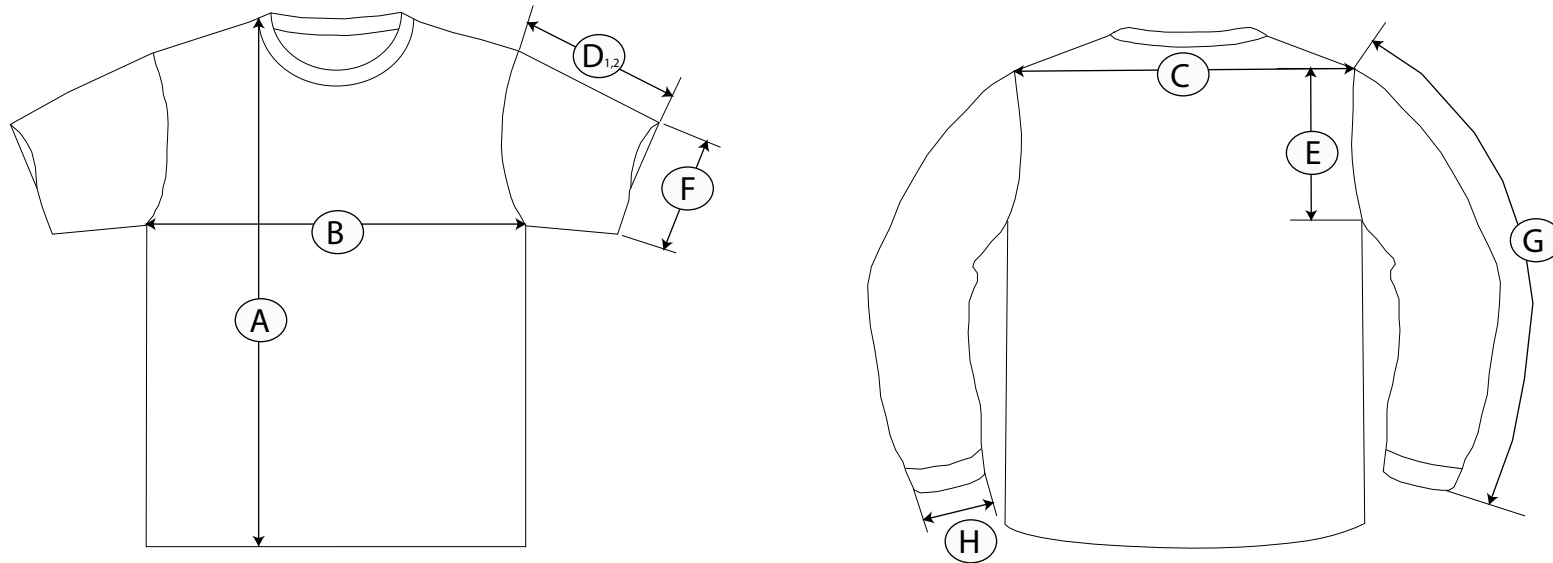

MEDIDAS(mm)	ref.	t0	t1	t2	t4	t6	t8	t10	t12	t14	t16	t18	t20	t22	t24
CUERPO															
Largo	A	370	400	430	460	500	540	580	620	650	690	720	720	770	790
Contorno	B	250	280	310	340	370	390	410	430	460	490	520	550	570	580
Espalda	C	240	260	280	300	320	340	360	380	400	420	440	460	480	500
MANGA CORTA															
Largo bocamanga	D1	120	130	140	150	160	170	180	190	200	210	220	230	240	250
Largo dobladillo	D2	110	120	130	140	150	160	170	180	190	200	210	220	230	240
Sisa	E	120	120	130	140	150	160	170	180	190	200	210	220	230	240
Bocamanga 1/2	F	80	80	90	100	110	120	130	140	150	155	160	160	170	170
MANGA LARGA															
Largo	G	360	370	380	390	430	470	510	540	570	600	630	650	670	690
Ancho boca puño	H	60	650	650	70	70	80	80	80	80	90	90	100	100	100



MOD: CHAQUETA CHANDAL

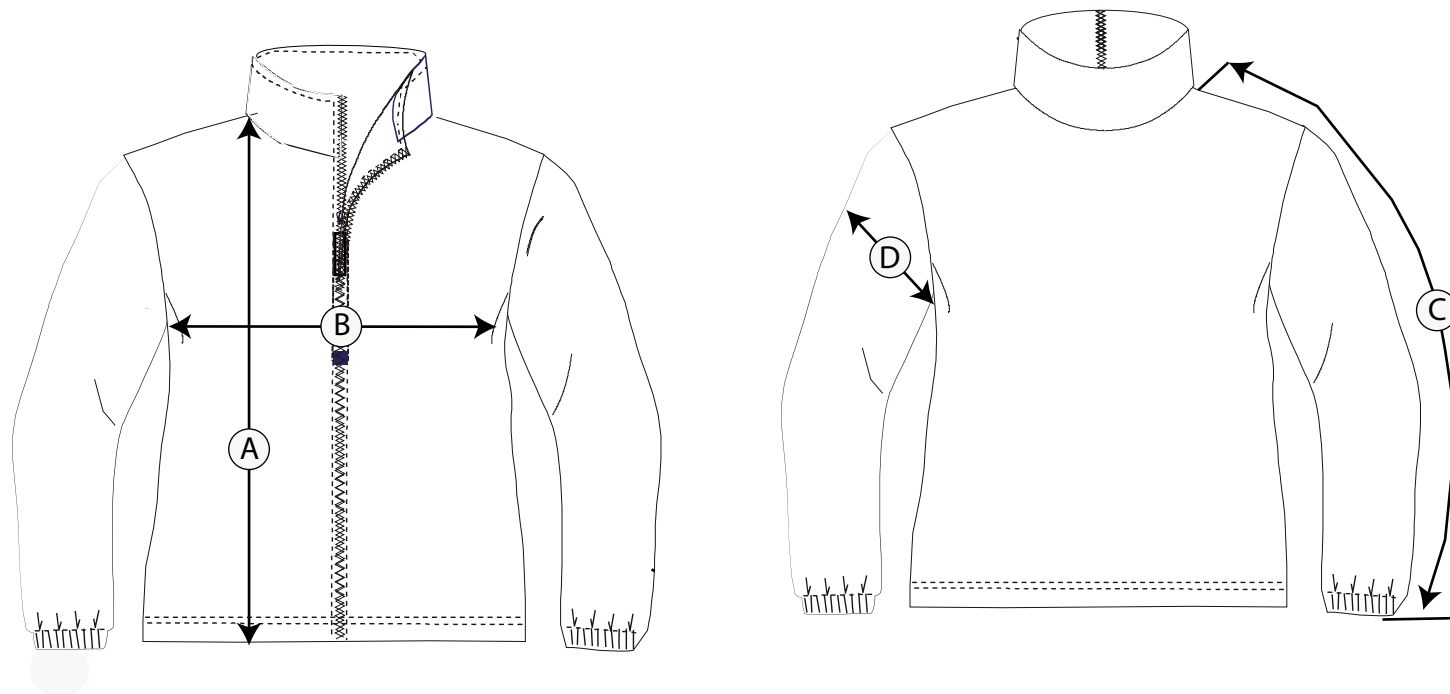

MEDIDA (mm)	REF.	T0	T1	T2	T4	T6	T8	T10	T12	T14	T16	T18	T20	T22	T24
Largo Prenda	A	340	370	400	430	470	510	550	585	625	645	665	685	725	725
Pecho	B	300	320	340	370	400	430	460	500	530	550	570	590	620	640
Largo Manga y Hombro	C	330	370	410	460	510	560	610	640	670	700	730	760	790	820
Ancho Manga	D	125	130	135	145	155	165	175	185	190	200	210	220	230	240

MEDIDAS DE CONTROL DE PRENDAS TERMINADA



MOD: Falda plisada tabla

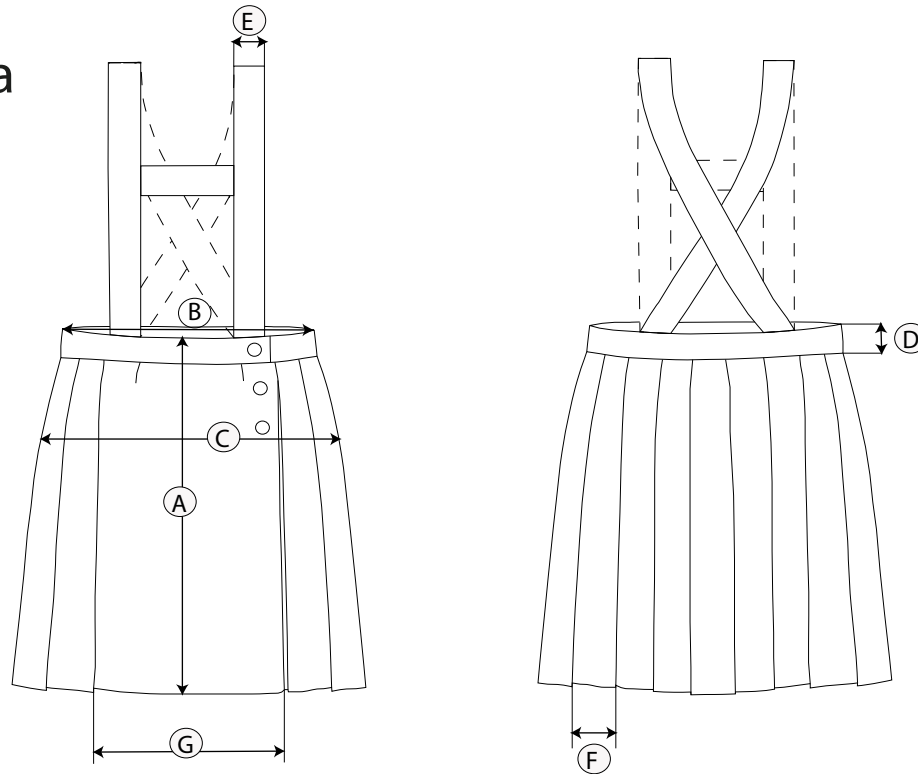

MEDIDAS(mm)	ref.	t0	t1	t2	t4	t6	t8	t10	t12	t14	t16	t18	t20	t22	t24
Largo	A	310	330	350	370	390	420	450	480	500	520	530	540	550	560
Cintura (funcida)	B	230	240	250	260	270	280	290	310	330	340	370	380	390	410
Cadera	C	270	290	310	330	350	370	390	410	430	460	490	520	530	540
Ancho cinturilla	D	35	35	35	35	35	35	35	35	35	35	35	35	35	35
Ancho tirante	E	30	30	30	30	30									
Ancho pala	F	220	220	220	220	220	240	240	240	260	260	260	280	280	280

OBSERVACIONES:

MOD: PANTALON CHANDAL

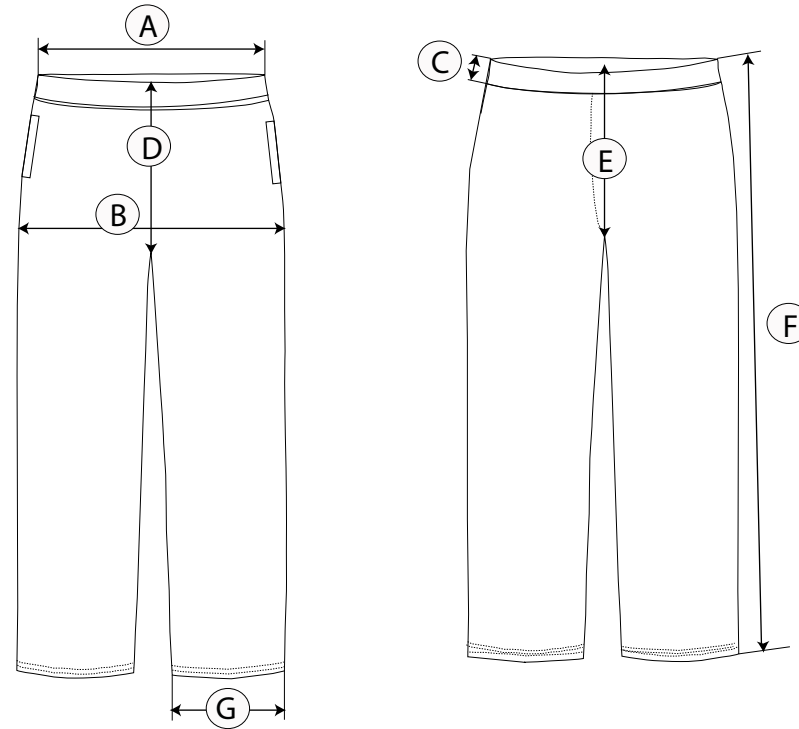

MEDIDA (mm)	REF.	T0	T1	T2	T4	T6	T8	T10	T12	T14	T16	T18	T20	T22	T24
Cintura (Funcida)	A	220	230	230	240	250	260	270	280	300	310	320	330	350	360
Cadera	B	290	320	350	380	400	430	460	480	510	530	550	570	590	610
Ancho Cintura	C	35	35	35	35	35	35	35	35	35	35	35	35	350	350
Caja delantero	D	200	205	215	225	235	245	260	270	280	290	300	310	325	330
Caja Trasero	E	240	250	260	270	280	295	310	320	345	350	360	380	390	405
Largo por costado	F	440	500	560	630	700	790	900	940	980	1020	1060	1100	1140	1170
Bajo 1/2	G	14	14	15	15	16	17	18	18	19	20	20	21	22	23

OBSERVACIONES:

MOD: PANTALON CHANDAL

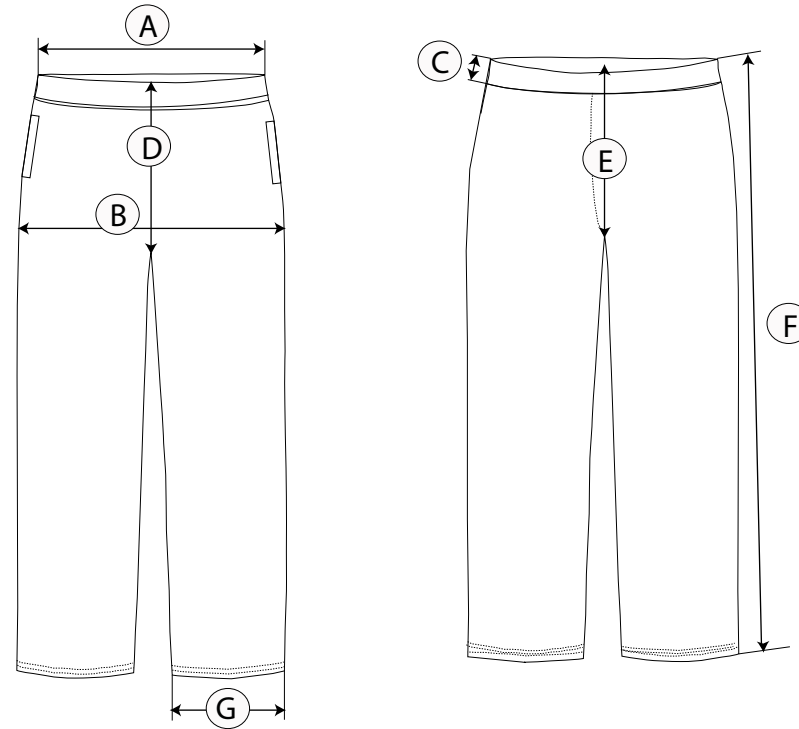

MEDIDA (mm)	REF.	T0	T1	T2	T4	T6	T8	T10	T12	T14	T16	T18	T20	T22	T24
Cintura (Funcida)	A	220	230	230	240	250	260	270	280	300	310	320	330	350	360
Cadera	B	290	320	350	380	400	430	460	480	510	530	550	570	590	610
Ancho Cintura	C	35	35	35	35	35	35	35	35	35	35	35	35	350	350
Caja delantero	D	200	205	215	225	235	245	260	270	280	290	300	310	325	330
Caja Trasero	E	240	250	260	270	280	295	310	320	345	350	360	380	390	405
Largo por costado	F	440	500	560	630	700	790	900	940	980	1020	1060	1100	1140	1170
Bajo 1/2	G	14	14	15	15	16	17	18	18	19	20	20	21	22	23

OBSERVACIONES:

MOD: Pantalón largo vestir chica

MEDIDAS DE CONTROL DE PRENDAS TERMINADA

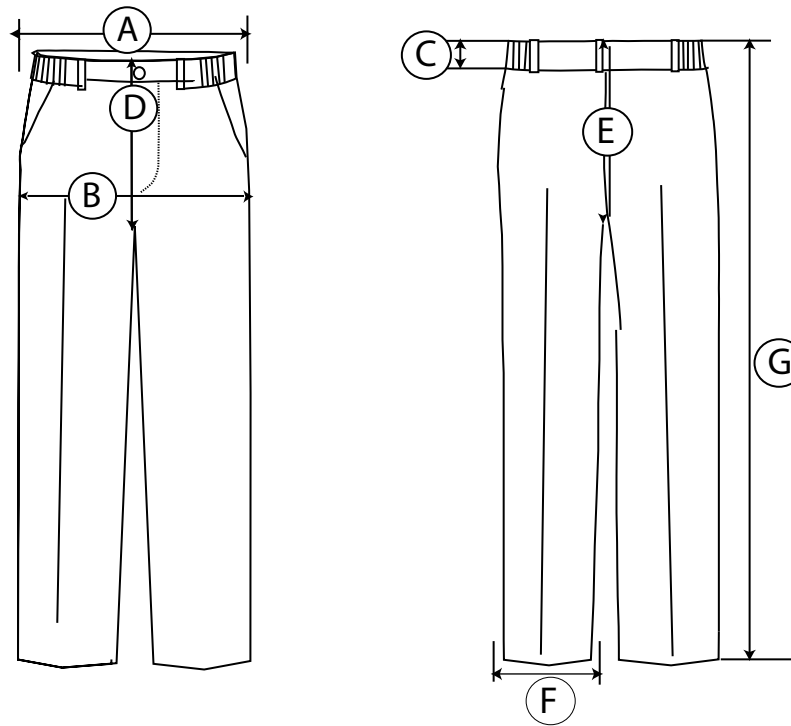

MEDIDAS(mm)		t12	t14	t16	t18	t20	t22	t24
Cintura	A	320	350	370	390	400	410	420
Cadera	B	430	450	470	500	520	540	560
Ancho cinturilla	C	35	35	35	35	35	35	35
Caja delantero	D	240	250	250	250	260	260	270
Caja trasero	E	340	350	360	370	380	390	400
Bajo 1/2	F	140	150	150	170	170	280	180
Largo por costado	G	980	1050	1110	1130	1150	1170	1180

OBSERVACIONES: Gomo tensora

MOD: Pantalón largo vestir



MEDIDAS DE CONTROL DE PRENDAS TERMINADA

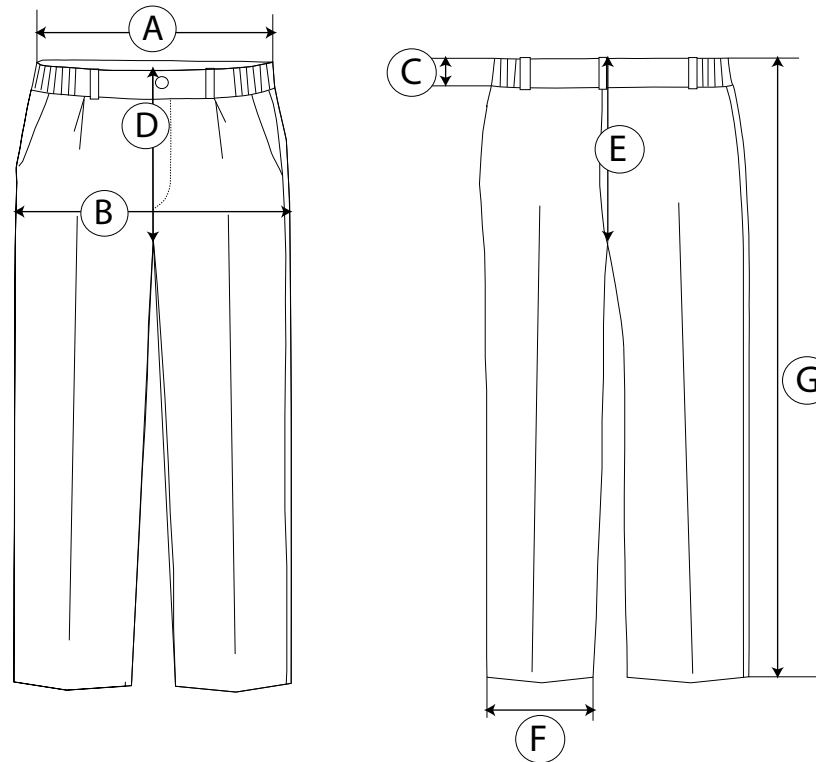

MEDIDAS(mm)	ref.	t0	t1	t2	t4	t6	t8	t10	t12	t14	t16	t18	t20	t22	t24
Cintura (funcida)	A	190	210	230	250	270	290	310	330	350	370	390	410	430	450
Cadera	B	260	290	320	350	390	410	440	470	500	530	560	590	620	650
Ancho cinturilla	C	350	350	350	350	350	350	350	350	350	350	350	350	350	350
Caja delantero	D	170	180	190	200	210	220	230	240	250	260	270	280	290	300
Caja trasero	E	220	230	245	270	280	280	310	320	340	360	380	400	420	440
Bajo 1/2	F	120	120	130	140	150	160	170	180	190	200	210	220	220	230
Largo por costado	G	550	590	630	670	730	820	880	950	1040	1130	1160	1170	1180	1190

OBSERVACIONES:

MOD: Polo manga corta

MEDIDAS DE CONTROL DE PRENDAS TERMINADA

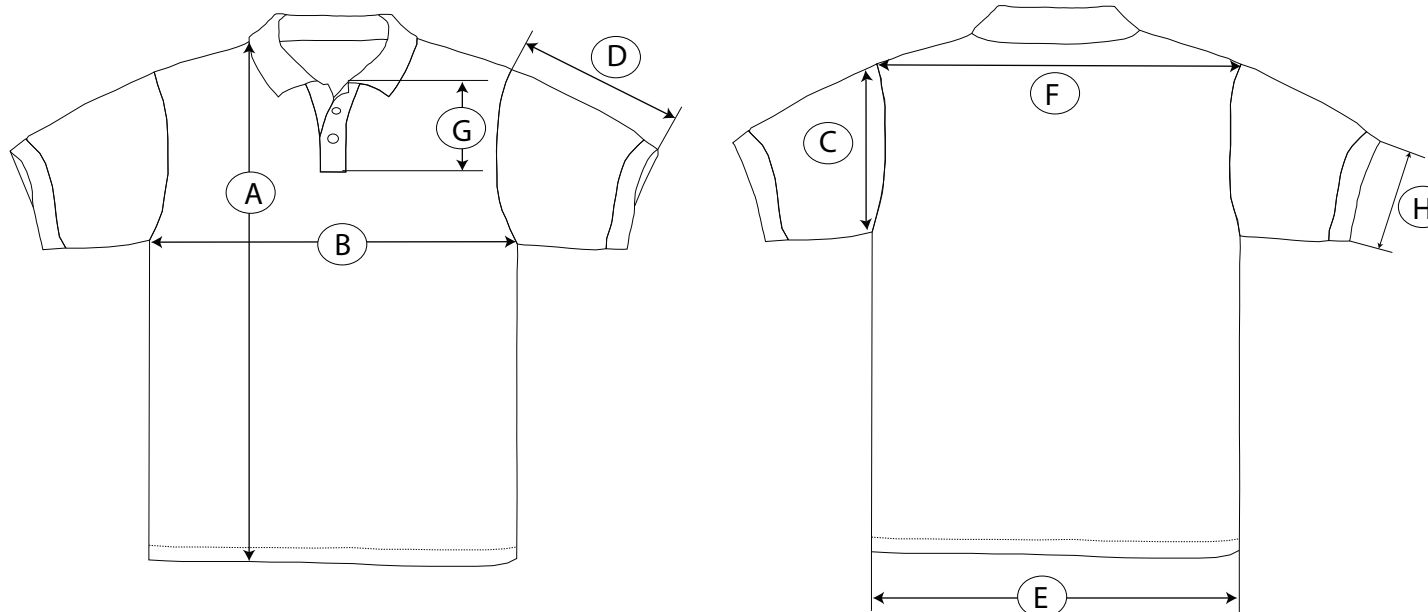

MEDIDAS(mm)	ref.	t0	t1	t2	t4	t6	t8	t10	t12	t14	t16	t18	t20	t22	t24
Largo cuerpo	A	350	390	430	470	510	550	580	610	630	650	670	690	710	730
Contorno	B	280	300	320	340	360	380	400	420	440	460	480	510	550	580
Sisa	C	120	130	140	150	160	170	180	190	200	220	230	240	260	270
Largo Manga	D	120	120	130	140	150	160	170	180	190	200	210	220	230	240
Ancho bajo	E	270	280	300	335	345	385	390	410	430	460	480	510	530	570
Espalda	F	230	250	270	290	300	320	340	350	370	390	400	420	430	450
Largo tapeta	G	110	110	110	125	130	130	140	140	145	150	150	150	150	150
Bocamanga	H	70	70	70	80	95	110	120	120	125	130	130	130	130	135

OBSERVACIONES: